

Article number: 2310431015S

Description: E+G Levelling elements  
LX.25-SW13-M8X34-S

## Measures

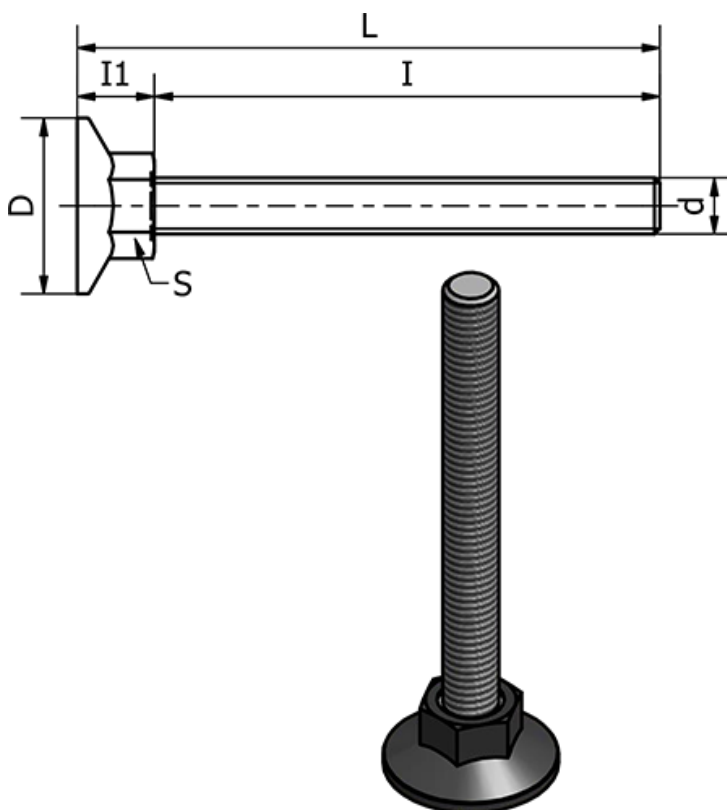

d = M8

D = 25

I = 34

I1 = 11

L = 45

S = 13

Static load in (N) = 2500

Type = Forzinket

Weight (g) = -